

1.Product Features

Product weight:5kg; TV size support:32-63"; Distance to the wall: 650-950mm; Maximum load:40kg; For VESA standard:600x400mm 400x400mm









2.Hardware List

















Important: We are not responsible for any personal injury or product damage due to mishandling, incorrect mounting, incorrect assembly or incorrect use of this product.

Note: The supplied wall mounting hardware is not for use on steel stud walls or cold cinder block walls. If you are uncertain what material your wall is constructed of or any question regarding the proper installation of this wall mount, contact a qualified contractor. If the hardware required is not including, please contact your local hardware store.

Caution: This LCD/Plasma wall mount is intended for use with television that does not exceed the maximum weight capacity designated. Using this mount with products heavier than the maximum weight indicated may result in instability causing possible injury.

Screw spare parts list

No.	Description	Specifications Model	Qty.
1		Join arm-1	x1
2		Wall plate	x1
3		Join arm-2	x1
4		plastic cover	x1
5		Arm	x2
6		plate	x1
7		Bar	x1
8		joint 1	x1

9		joint 2	x1
A		M8 Plastic screw	x4
B		M5.3x40mm Wallboard screw	x4
C		M4x5mm Wood screw	x1
D		M8x45mm Cross round screw	x1
E		M8 Screw nut	x1
F		Φ8 Iron washer	x1
G		M6x14 Carriage screw	x4
H		Adjustment screw	x1
I		M8x16mm Cross round screw	x4
J		M6x20mm Cross round screw	x4
K		washer	x4
L		Φ6plastic spacer	x4
M		M6x65mm Cross round screw	x1
N		Φ6x16 washer	x14
O		M6 Screw nut	x5

Instruction of installation operation

1

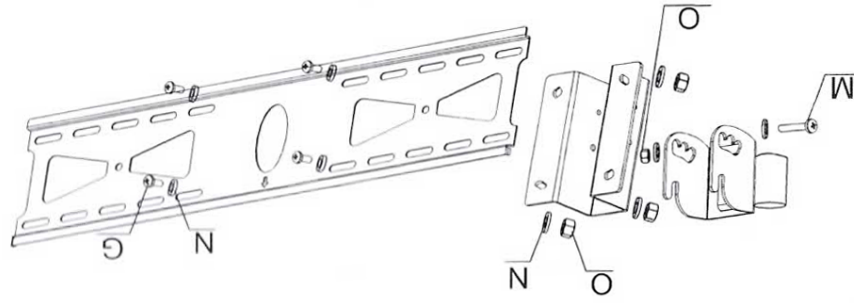

Put the wall plate on the join arm-1 and then do the same to the plastic cover. Using cross round screw (D) and washer(F) to joint the join arm-1 and join arm-2.

2

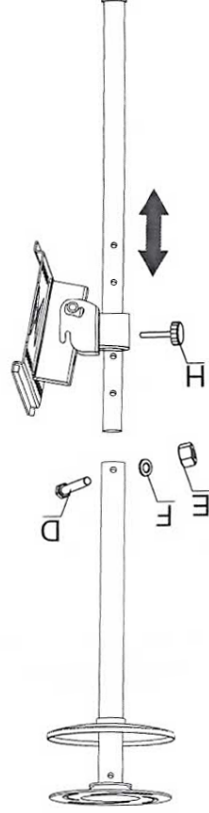

3

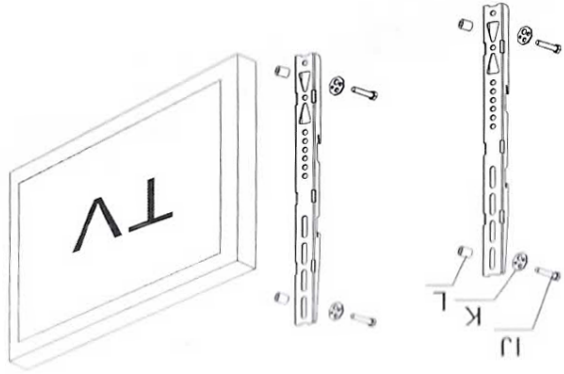

Using Long bolt(J), washer(K) and Spacer (L) to mount TV set to the aluminum siding.

4

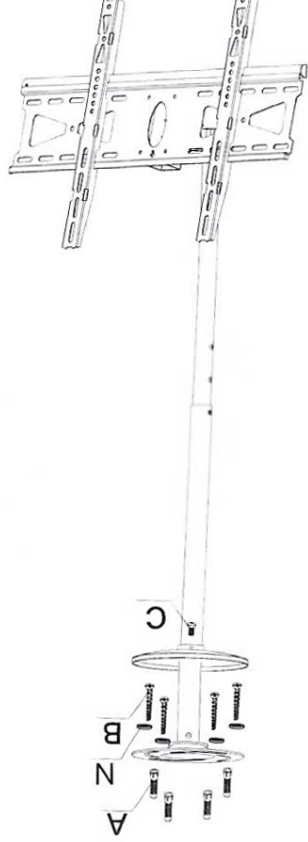

Using the bubble level to ensure the wall plate is level. Pre-drill 4 holes with a 10mm bit to 50mm deep. Insert wall anchors into the holes, then using long bolts to mount the wall to studs.